

130-3173 ALTO[®] 1.28



Round Front, Vitreous China, Two-Piece Toilet

FEATURES

- 3-bolt SmartFasten™ tank-to-bowl connection
- 1.28 gpf / 4.8 lpf high efficiency water consumption
- Uses 20% less water than conventional toilets
- Round front bowl
- 3-2" hybrid flapper flush valve
- Fluidmaster® anti-siphon pilot fill valve
- 12" rough-in
- Model 31 color-match, plastic trip lever
- 2" glazed trapway
- The Mansfield® Limited Lifetime Warranty
- Available in White, Biscuit, and Bone



MODEL 130-3173

Toilet seat not included

Available as CTK





ROUND



CTK

COMPONENTS

MODEL #	DESCRIPTION	CODES/STANDARDS
130-3173	Round front, two-piece toilet	  
130	Round front, toilet bowl only. Less toilet seat. Specify color.	
3173	Tank and cover only with left hand, front-mount, color-match, plastic trip lever. Fluidmaster® anti-siphon pilot fill valve. Less supply. Specify color.	

TANK TRIM & REPLACEMENT PARTS

31	Trip lever - color-match, plastic trip lever, left hand
228	3-2" Hybrid flapper flush valve
400A	Fluidmaster® anti-siphon pilot fill valve
2206	Anti-siphon pilot fill valve (compatible replacement)
630-0207	3" Replacement flapper kit
160-LID	Tank lid





130-3173 ALTO® 1.28



Round Front, Vitreous China, Two-Piece Toilet

SPECIFICATIONS

MODEL #	DESCRIPTION	CODES/STANDARDS
130-3173	Round front (1.28 gpf / 4.8 lpf) two-piece toilet	  

MATERIAL	Vitreous China
WATER PRESSURE RANGE	20 to 80 PSI
FLUSH SYSTEM	3-2" Hybrid flapper flush valve
WATER USAGE	1.28 gpf / 4.8 lpf
WATER SURFACE AREA	8" X 9"
ROUGH-IN	12"
MaP RATING	800 grams

TRAP DIAMETER	2"
TRAP SEAL	2-5/8"
SHIPPING WEIGHT	Model 130 - 46 lbs. (21 kg) Model 3173 - 34 lbs. (15 kg)
WARRANTY	Vitreous China - Limited Lifetime Tank Trim - Limited One Year

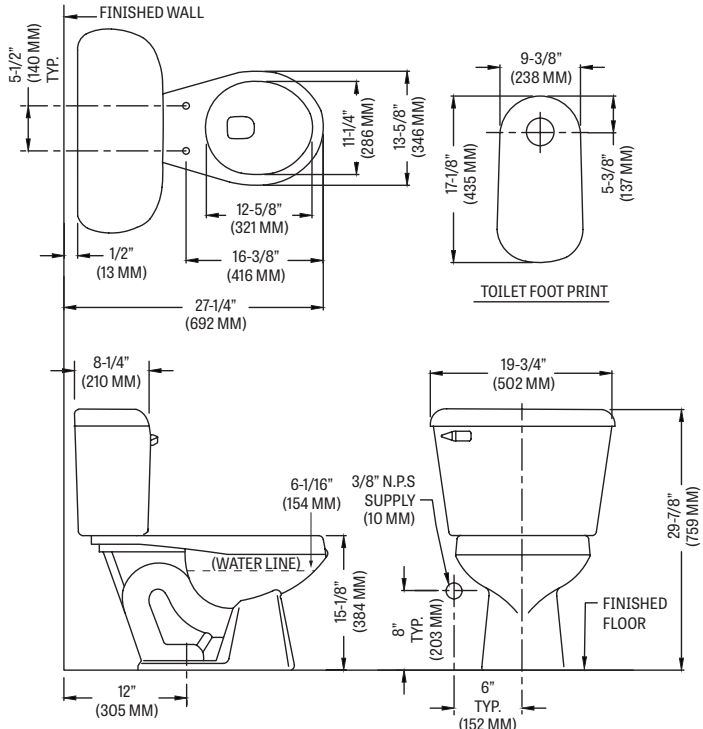
TANK OPTIONS	TECHNICAL INFORMATION												
	Note: these dimensions are nominal and subject to change without notice.												
<table border="1"> <tbody> <tr> <td>3173</td> <td>Standard 1.28 gpf configuration: 3-2" hybrid flapper flush valve, Fluidmaster® anti-siphon pilot fill valve, left hand, color-match trip lever.</td> </tr> <tr> <td>3173RH</td> <td>Variation of model 3173, with right hand, color-match trip lever.</td> </tr> <tr> <td>3165</td> <td>Variation of model 3173, with cover lock.</td> </tr> <tr> <td>3174</td> <td>Variation of model 3173, with tank liner.</td> </tr> <tr> <td>3120</td> <td>Variation of model 3173, with left hand, chrome trip lever.</td> </tr> <tr> <td>3125</td> <td>Variation of model 3173, 14" rough-in.</td> </tr> </tbody> </table>	3173	Standard 1.28 gpf configuration: 3-2" hybrid flapper flush valve, Fluidmaster® anti-siphon pilot fill valve, left hand, color-match trip lever.	3173RH	Variation of model 3173, with right hand, color-match trip lever.	3165	Variation of model 3173, with cover lock.	3174	Variation of model 3173, with tank liner.	3120	Variation of model 3173, with left hand, chrome trip lever.	3125	Variation of model 3173, 14" rough-in.	
3173	Standard 1.28 gpf configuration: 3-2" hybrid flapper flush valve, Fluidmaster® anti-siphon pilot fill valve, left hand, color-match trip lever.												
3173RH	Variation of model 3173, with right hand, color-match trip lever.												
3165	Variation of model 3173, with cover lock.												
3174	Variation of model 3173, with tank liner.												
3120	Variation of model 3173, with left hand, chrome trip lever.												
3125	Variation of model 3173, 14" rough-in.												

Fixture performance and specifications meet or exceed ASME A112.19.2/CSA B45.1 standards, and other state and local codes.

